

FEATURES

- Windowed watchdog, 8 timeout options
- 26 reset threshold options
 - 2.5 V to 5 V in 100 mV increments
- 4 reset timeout options
 - 1 ms, 20 ms, 140 ms, and 1120 ms (minimum)
- Manual reset input
- Open-drain or push-pull $\overline{\text{RESET}}$ outputs
- Low power consumption
- Specified over wide temperature range (-40°C to $+125^{\circ}\text{C}$)
- Qualified for automotive applications
- 5-lead SOT-23 package

APPLICATIONS

- Automotive
- Microprocessor systems
- Computers
- Controllers
- Intelligent instruments
- Portable equipment

GENERAL DESCRIPTION

The [ADM8323/ADM8324](#) are supervisory circuits that monitor power supply voltage levels and code execution integrity in microprocessor-based systems. An on-chip watchdog timer checks for activity within a preset timeout window. A reset signal can also be asserted by an external push-button switch through a manual reset input. The $\overline{\text{RESET}}$ output is either push-pull ([ADM8323](#)) or open-drain ([ADM8324](#)).

A watchdog failure results in a low output on the $\overline{\text{RESET}}$ pin. A failure can be triggered either by a fast watchdog error (watchdog pulses too close together) or by a slow watchdog error (no watchdog pulse within the timeout period). This effectively gives a window to observe the watchdog pulse. The watchdog timeout is measured from the last falling edge of the watchdog input (WDI). There are eight different watchdog windows available, as shown in Table 5.

FUNCTIONAL BLOCK DIAGRAMS

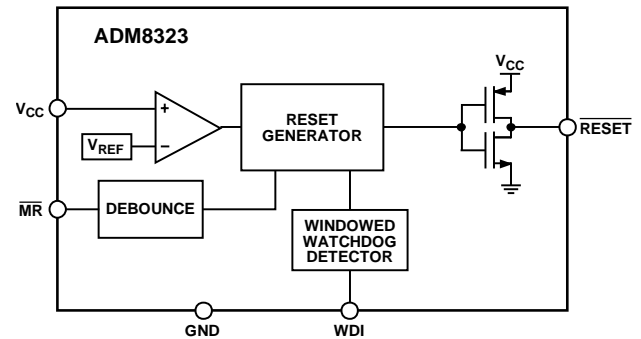

Figure 1.

11802-001

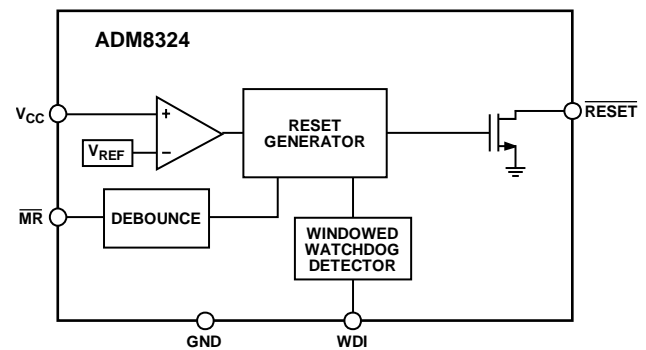

Figure 2.

11802-002

Each device is available in a choice of 26 reset threshold options from 2.5 V to 5 V in 100 mV increments. There are also four reset timeout options of 1 ms, 20 ms, 140 ms, and 1120 ms (minimum). Not all device options are available as standard models. See the Ordering Guide for details.

The [ADM8323/ADM8324](#) are available in a 5-lead SOT-23 package and typically consume only 10 μA , making them suitable for use in low power portable applications.

TABLE OF CONTENTS

Features	1	Push-Pull $\overline{\text{RESET}}$ Output	10
Applications.....	1	Open-Drain $\overline{\text{RESET}}$ Output	10
Functional Block Diagrams.....	1	Manual Reset Input	10
General Description	1	Windowed Watchdog Input.....	10
Revision History	2	Applications Information	11
Specifications.....	3	Watchdog Input Current	11
Absolute Maximum Ratings.....	5	Negative Going V_{CC} Transients.....	11
ESD Caution.....	5	Ensuring $\overline{\text{RESET}}$ Valid to $V_{CC} = 0\text{ V}$	11
Pin Configuration and Function Descriptions.....	6	Model Options	12
Typical Performance Characteristics	7	Outline Dimensions	13
Theory of Operation	10	Ordering Guide	13
Circuit Description.....	10	Automotive Products.....	14

REVISION HISTORY

2/2018—Rev. A to Rev. B

Changes to General Description Section	1
Added Note 3, Table 1	3
Changed Model Options Section to Device Model Options Section.....	12
Changes to Device Model Options Section	12
Deleted Table 7; Renumbered Sequentially.....	13
Changes to Ordering Guide	13

3/2016—Rev. 0 to Rev. A

Change to Model Options Section Title	12
Changes to Table 7.....	13

10/2013—Revision 0: Initial Version

SPECIFICATIONS

$V_{CC} = (V_{TH} + 1.5\%)$ to 5.5 V, $T_A = -40^\circ\text{C}$ to $+125^\circ\text{C}$, unless otherwise noted. Typical values are at $T_A = 25^\circ\text{C}$.

Table 1.

Parameter	Min	Typ	Max	Unit	Test Conditions/Comments
SUPPLY					
V_{CC} Operating Voltage Range ¹	0.9		5.5	V	
V_{CC} that Guarantees Valid Output	0.9				
Supply Current		10	20	μA	$V_{CC} = 5.5\text{ V}$, $\text{WDI} = 0\text{ V}$
		10	18	μA	$V_{CC} = 3.6\text{ V}$, $\text{WDI} = 0\text{ V}$
RESET THRESHOLD VOLTAGE^{2,3}					
	$V_{TH} - 1\%$	V_{TH}	$V_{TH} + 1\%$	V	$T_A = 25^\circ\text{C}$
	$V_{TH} - 1.5\%$	V_{TH}	$V_{TH} + 1.5\%$	V	$T_A = -40^\circ\text{C}$ to $+125^\circ\text{C}$
RESET THRESHOLD TEMPERATURE COEFFICIENT					
		20		ppm/ $^\circ\text{C}$	
RESET THRESHOLD HYSTERESIS					
		$2.5 \times V_{TH}$		mV	
RESET TIMEOUT PERIOD³					
Reset Timeout Option A	1	1.4	1.8	ms	See Table 4
Reset Timeout Option B	20	28	36	ms	
Reset Timeout Option C	140	200	260	ms	
Reset Timeout Option D	1120	1600	2080	ms	
V_{CC} TO RESET DELAY, t_{RD}					
		90		μs	V_{CC} falling at 1 mV/ μs
PUSH-PULL OUTPUT (ADM8323)					
$\overline{\text{RESET}}$ Output Voltage			0.2	V	$V_{CC} \geq 0.9\text{ V}$, $I_{\text{SINK}} = 25\ \mu\text{A}$
			0.2	V	$V_{CC} \geq 1.2\text{ V}$, $I_{\text{SINK}} = 100\ \mu\text{A}$
			0.2	V	$V_{CC} \geq 2.7\text{ V}$, $I_{\text{SINK}} = 1.2\text{ mA}$
			0.3	V	$V_{CC} \geq 4.5\text{ V}$, $I_{\text{SINK}} = 3.2\text{ mA}$
	$0.9 \times V_{CC}$			V	$V_{CC} \geq 2.7\text{ V}$, $I_{\text{SOURCE}} = 500\ \mu\text{A}$
	$0.9 \times V_{CC}$			V	$V_{CC} \geq 4.5\text{ V}$, $I_{\text{SOURCE}} = 800\ \mu\text{A}$
$\overline{\text{RESET}}$ Rise Time		50	100	ns	From 10% to 90% V_{CC} , $C_L = 5\text{ pF}$, $V_{CC} = 3.3\text{ V}$
OPEN-DRAIN OUTPUT (ADM8324)					
$\overline{\text{RESET}}$ Output Voltage			0.2	V	$V_{CC} \geq 0.9\text{ V}$, $I_{\text{SINK}} = 25\ \mu\text{A}$
			0.2	V	$V_{CC} \geq 1.2\text{ V}$, $I_{\text{SINK}} = 100\ \mu\text{A}$
			0.2	V	$V_{CC} \geq 2.7\text{ V}$, $I_{\text{SINK}} = 1.2\text{ mA}$
			0.3	V	$V_{CC} \geq 4.5\text{ V}$, $I_{\text{SINK}} = 3.2\text{ mA}$
Open-Drain Reset Output Leakage Current			1	μA	
WATCHDOG INPUT³					
Watchdog Timeout Period (Fast), $t_{WD-FAST}$					
Watchdog Timeout Option A	1		1.5	ms	See Table 5
Watchdog Timeout Option B	10		15	ms	
Watchdog Timeout Option C	10		15	ms	
Watchdog Timeout Option D	10		15	ms	
Watchdog Timeout Option E	10		15	ms	
Watchdog Timeout Option F	16		24	ms	
Watchdog Timeout Option G	27		41	ms	
Watchdog Timeout Option H	512		768	ms	
Watchdog Timeout Period (Slow), $t_{WD-SLOW}$					
Watchdog Timeout Option A	10		15	ms	
Watchdog Timeout Option B	100		150	ms	
Watchdog Timeout Option C	300		450	ms	
Watchdog Timeout Option D	10		15	sec	
Watchdog Timeout Option E	60		90	sec	
Watchdog Timeout Option F	44		66	ms	
Watchdog Timeout Option G	76		114	ms	
Watchdog Timeout Option H	1.24		1.86	sec	

Parameter	Min	Typ	Max	Unit	Test Conditions/Comments
WDI Pulse Width	200			ns	$V_{IL} = 0.3 \times V_{CC}$, $V_{IH} = 0.7 \times V_{CC}$
WDI Glitch Immunity		100		ns	
WDI Input Threshold	$0.3 \times V_{CC}$		$0.7 \times V_{CC}$	V	$V_{WDI} = V_{CC}$ $V_{WDI} = 0\text{ V}$
WDI Input Current		0.35	1	μA	
	-1	-0.35		μA	
MANUAL RESET INPUT					
V_{IL}			0.8	V	$V_{CC} = 5\text{ V}$
V_{IH}	2.0			V	
$\overline{\text{MR}}$ Input Pulse Width	1			μs	
$\overline{\text{MR}}$ Glitch Rejection		100		ns	
$\overline{\text{MR}}$ Pull-Up Resistance	35	75	125	$\text{k}\Omega$	
$\overline{\text{MR}}$ to Reset Delay		350		ns	

¹ The device switches from undervoltage reset to normal operation when $1.5\text{ V} < V_{CC} < 2.5\text{ V}$.

² The device monitors V_{CC} through an internal factory trimmed voltage divider, which programs the nominal reset threshold. Factory trimmed reset thresholds are available in approximately 100 mV increments from 2.5 V to 5 V.

³ Not all device options are available as standard models. See the Ordering Guide for details.

ABSOLUTE MAXIMUM RATINGS

$T_A = 25^\circ\text{C}$, unless otherwise noted.

Table 2.

Parameter	Rating
V_{CC}	-0.3 V to +6 V
All Other Pins	-0.3 V to ($V_{CC} + 0.3$ V)
Output Current ($\overline{\text{RESET}}$)	20 mA
Operating Temperature Range	-40°C to +125°C
Storage Temperature Range	-65°C to +150°C
θ_{JA} Thermal Impedance, SOT-23	270°C/W
Lead Temperature	
Soldering (10 sec)	300°C
Vapor Phase (60 sec)	215°C
Infrared (15 sec)	220°C

Stresses at or above those listed under Absolute Maximum Ratings may cause permanent damage to the product. This is a stress rating only; functional operation of the product at these or any other conditions above those indicated in the operational section of this specification is not implied. Operation beyond the maximum operating conditions for extended periods may affect product reliability.

ESD CAUTION



ESD (electrostatic discharge) sensitive device. Charged devices and circuit boards can discharge without detection. Although this product features patented or proprietary protection circuitry, damage may occur on devices subjected to high energy ESD. Therefore, proper ESD precautions should be taken to avoid performance degradation or loss of functionality.

PIN CONFIGURATION AND FUNCTION DESCRIPTIONS

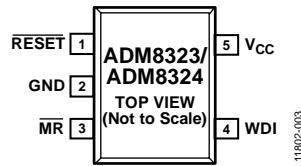

Figure 3. Pin Configuration

Table 3. Pin Function Descriptions

Pin No.	Mnemonic	Description
1	RESET	Active Low Reset Output. Asserted whenever V_{CC} is below the reset threshold, V_{TH} . This pin is a push-pull output stage for the ADM8323 and an open-drain output stage for the ADM8324 .
2	GND	Ground.
3	MR	Manual Reset Input. This is an active low input that, when forced low for greater than the glitch filter time, generates a reset. It features a 75 k Ω internal pull-up resistor.
4	WDI	Watchdog Input. Generates a reset if the WDI pulse is not within the watchdog window.
5	V_{CC}	Power Supply Voltage Being Monitored.

TYPICAL PERFORMANCE CHARACTERISTICS

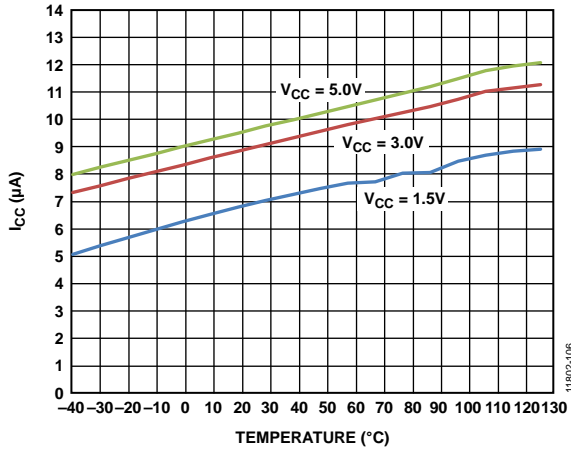

Figure 4. Supply Current (I_{CC}) vs. Temperature

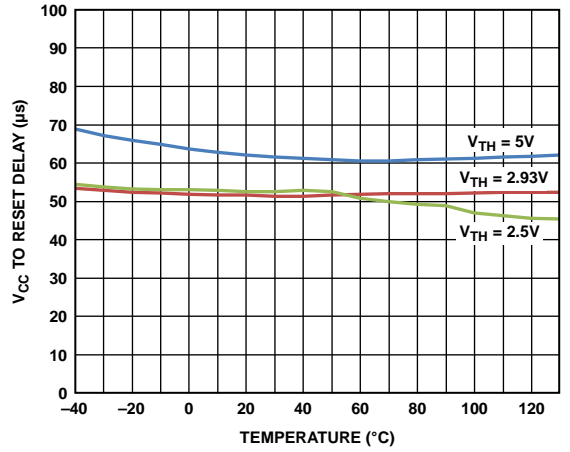

Figure 7. V_{CC} to Reset Delay vs. Temperature

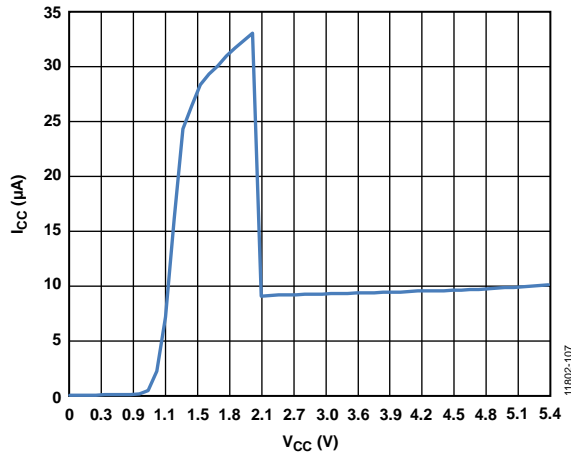

Figure 5. Supply Current (I_{CC}) vs. Supply Voltage (V_{CC})

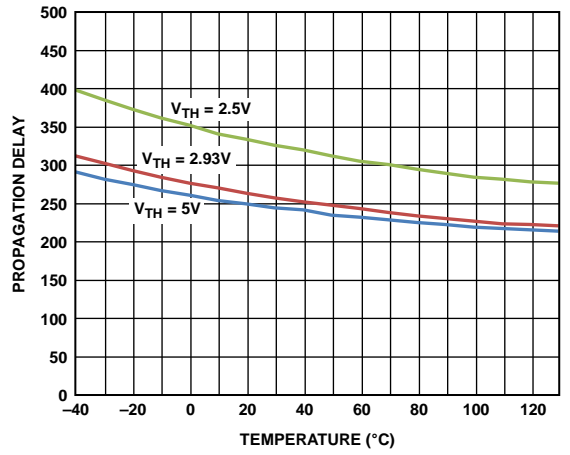

Figure 8. Manual Reset to Reset Propagation Delay vs. Temperature

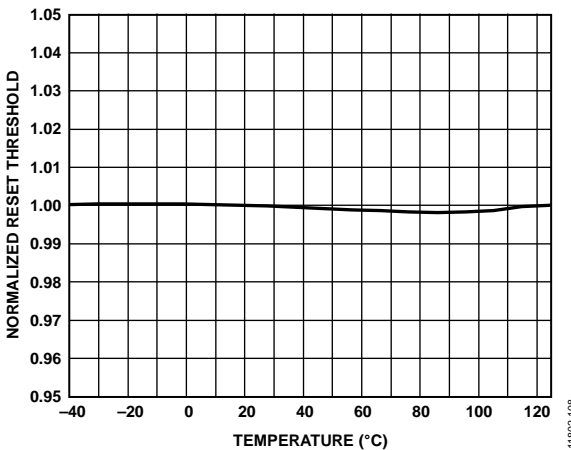

Figure 6. Normalized Reset Threshold vs. Temperature

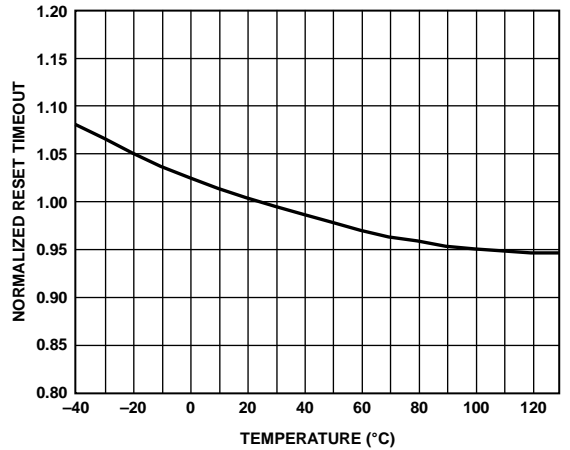

Figure 9. Normalized Reset Timeout vs. Temperature

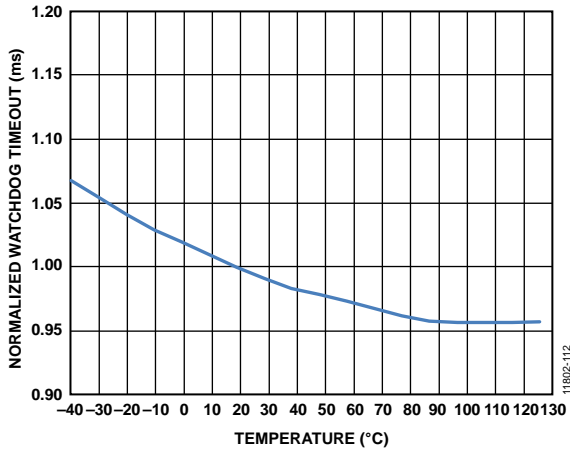

Figure 10. Normalized Watchdog Timeout vs. Temperature, Fast Timeout

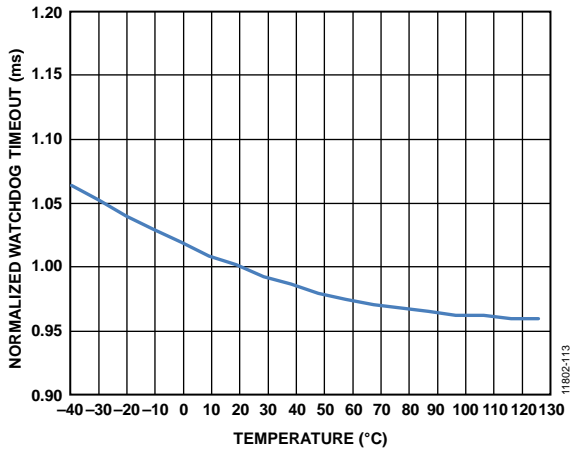

Figure 11. Normalized Watchdog Timeout vs. Temperature, Slow Timeout

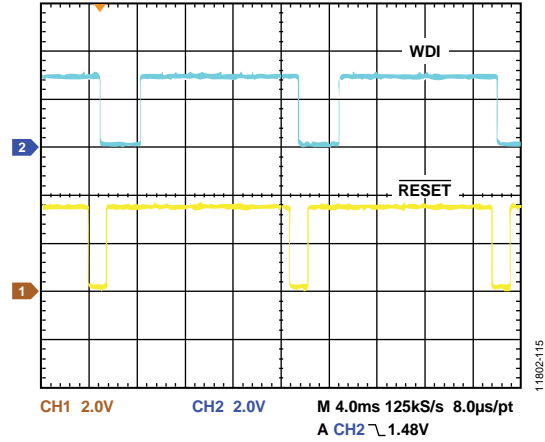

Figure 13. Slow Watchdog Timeout Period, Watchdog Timeout Option A

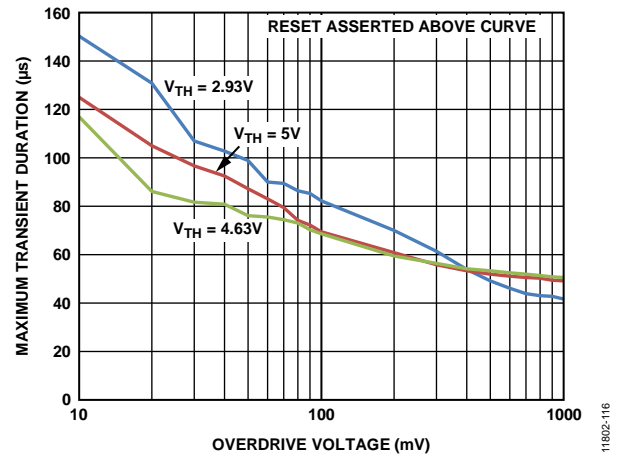

Figure 14. Maximum V_{CC} Transient Duration vs. Reset Threshold Overdrive

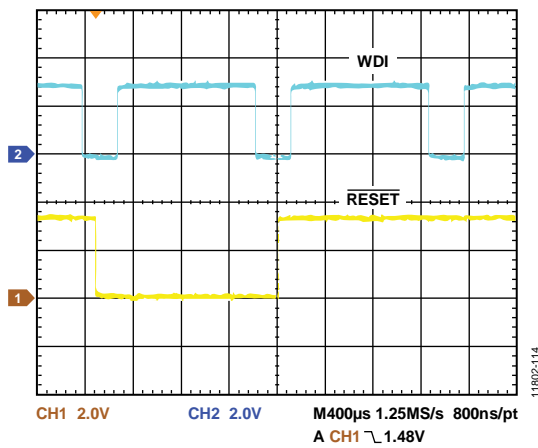

Figure 12. Fast Watchdog Timeout Period, Watchdog Timeout Option A

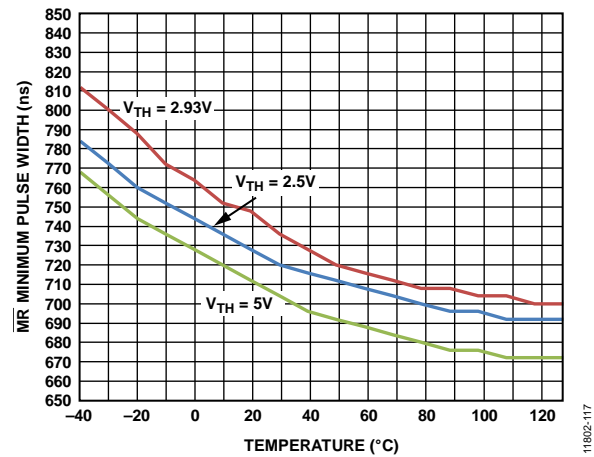

Figure 15. Manual Reset (\overline{MR}) Minimum Pulse Width vs. Temperature

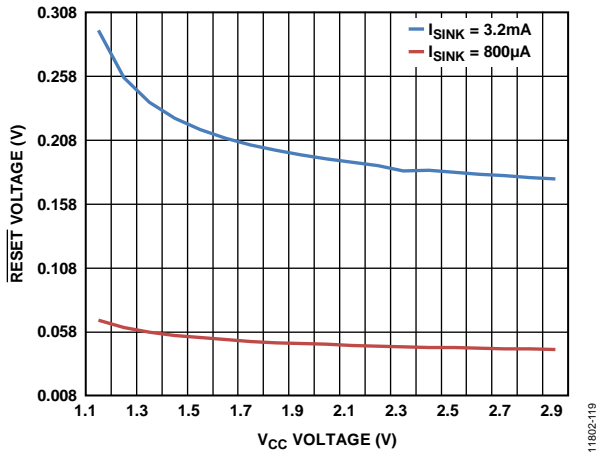

Figure 16. $\overline{\text{RESET}}$ Open-Drain V_{OL} Voltage vs. V_{CC} Voltage ($V_{TH} = 3\text{ V}$)

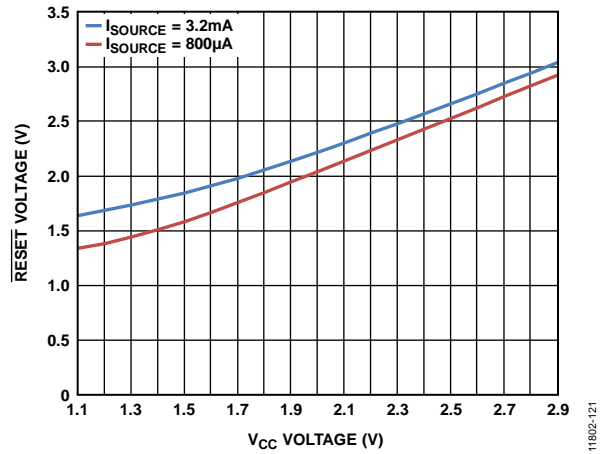

Figure 18. $\overline{\text{RESET}}$ Push-Pull V_{OH} Voltage vs. V_{CC} Voltage ($V_{TH} = 3\text{ V}$)

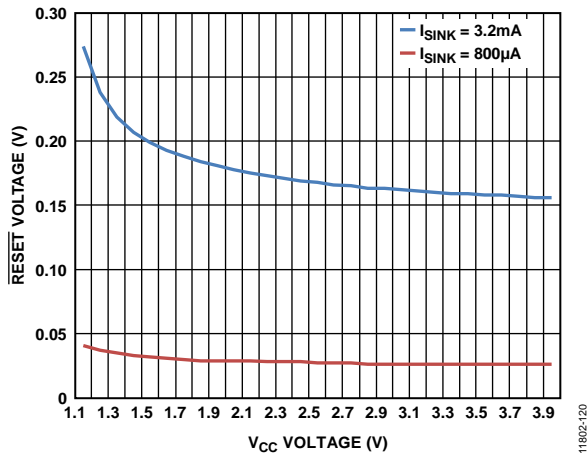

Figure 17. $\overline{\text{RESET}}$ Push-Pull V_{OL} Voltage vs. V_{CC} Voltage ($V_{TH} = 4\text{ V}$)

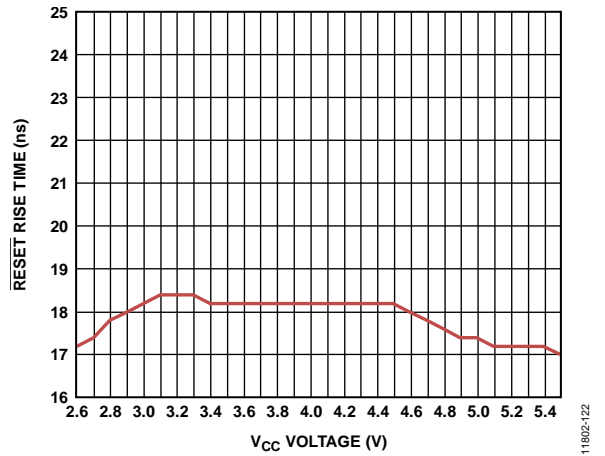

Figure 19. $\overline{\text{RESET}}$ Push-Pull Rise Time vs. V_{CC} Voltage

THEORY OF OPERATION

CIRCUIT DESCRIPTION

The ADM8323/ADM8324 provide microprocessor supply voltage supervision by controlling the microprocessor reset input. Code execution errors are avoided during power-up, power-down, and brownout conditions by asserting a reset signal when the supply voltage is below a preset threshold and by allowing supply voltage stabilization with a fixed timeout reset pulse after the supply voltage rises above the threshold. In addition, problems with microprocessor code execution can be monitored and corrected with a windowed watchdog timer. If the user detects a problem with system operation, a manual reset input is available to reset the microprocessor, for example, by means of an external push-button switch.

PUSH-PULL RESET OUTPUT

The ADM8323 features an active low push-pull reset output. The reset signal is guaranteed to be valid for V_{CC} down to 0.9 V. The reset output is asserted when V_{CC} is below the reset threshold (V_{TH}), when \overline{MR} is driven low, or when WDI is not serviced within the watchdog timeout window. Reset remains asserted for the duration of the reset active timeout period (t_{RP}) after V_{CC} rises above the reset threshold and \overline{MR} transitions from low to high or after the watchdog timer fault occurs. Figure 20 illustrates the behavior of the reset output.

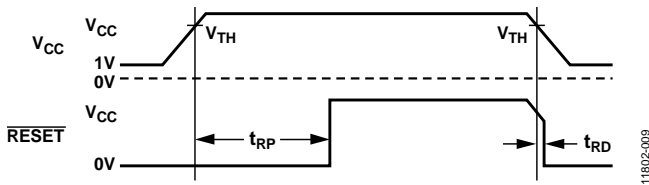

Figure 20. Reset Timing Diagram

OPEN-DRAIN RESET OUTPUT

The ADM8324 has an active low, open-drain reset output. This output structure requires an external pull-up resistor to connect the reset output to a voltage rail no higher than V_{CC} . Use a resistor that complies with the logic low and logic high voltage level requirements of the microprocessor while supplying input current and leakage paths on the RESET line. A 10 k Ω resistor is adequate in most situations.

MANUAL RESET INPUT

The ADM8323/ADM8324 feature a manual reset input (\overline{MR}), which when driven low, asserts the reset output. When \overline{MR} transitions from low to high, the reset output remains asserted for the duration of the reset active timeout period before deasserting. The \overline{MR} input has a 75 k Ω , internal pull-up resistor so that the input is always high when unconnected. An external push-button switch can be connected between \overline{MR} and ground so the user can generate a reset. Debounce circuitry for this purpose is integrated on chip.

Noise immunity is provided on the \overline{MR} input, and fast, negative going transients of up to 100 ns (typical) are ignored. A 0.1 μ F capacitor between MR and ground provides additional noise immunity.

WINDOWED WATCHDOG INPUT

The ADM8323/ADM8324 feature a windowed watchdog timer that monitors microprocessor activity. A timer circuit is cleared with every high to low logic transition on the watchdog input pin (WDI), which detects pulses as short as 200 ns. If this watchdog pulse does not occur within the defined time window, a reset asserts. Failure of the microprocessor to toggle WDI within the watchdog window indicates a code execution error and, therefore, the generated reset pulse restarts the microprocessor in a known state.

As well as logic transitions on WDI, the watchdog timer is also cleared by a reset assertion due to an undervoltage condition on V_{CC} or due to \overline{MR} being pulled low. When a reset is asserted, the watchdog timer is cleared and does not begin counting again until the reset deasserts. The windowed watchdog timer cannot be disabled.

All WDI input pulses are ignored while a reset is asserted. After the reset deasserts, the first WDI falling edge is ignored for the fast fault condition.

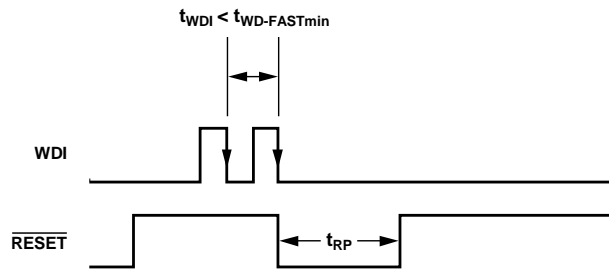

Figure 21. Watchdog Fast Timeout Fault

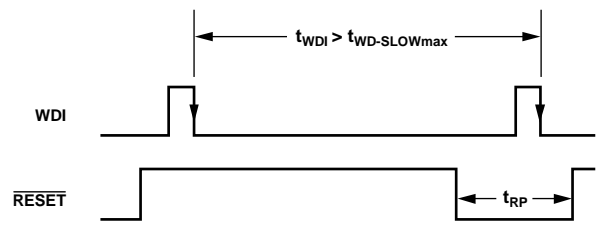

Figure 22. Watchdog Slow Timeout Fault

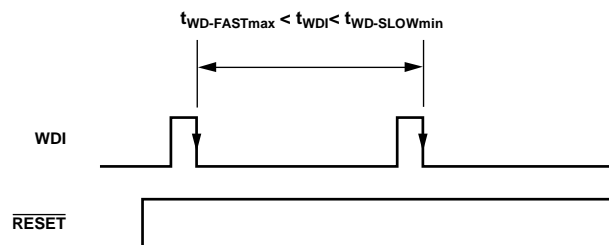

Figure 23. Normal Watchdog Operation

APPLICATIONS INFORMATION

WATCHDOG INPUT CURRENT

There is no way to disable the windowed watchdog functionality. Do not leave the WDI pin floating because this is not a valid mode of operation. If the WDI pin is not in a defined state at startup, this can lead to high supply current until the microprocessor is enabled and takes control of the WDI pin. A solution to this is to add a 100 k Ω pull-up or pull-down resistor on the WDI pin to hold it in a defined state until the microprocessor is enabled.

NEGATIVE GOING V_{CC} TRANSIENTS

To avoid unnecessary resets caused by fast power supply transients, the ADM8323/ADM8324 are equipped with glitch rejection circuitry. The typical performance characteristic in Figure 14 plots V_{CC} transient duration vs. reset threshold overdrive. The curves show combinations of reset threshold overdrive and duration for which a reset is not generated for 5 V, 4.63 V, and 2.93 V reset threshold devices. For example, with the 2.93 V threshold, a transient that goes 100 mV below the threshold and lasts 80 μ s typically does not cause a reset. However, if the transient is any larger in reset threshold overdrive or duration, a reset generates. An optional 0.1 μ F bypass capacitor mounted near V_{CC} provides additional glitch rejection.

ENSURING $\overline{\text{RESET}}$ VALID TO $V_{CC} = 0$ V

The reset output is guaranteed valid for V_{CC} as low as 0.9 V. However, by using an external resistor with the push-pull configured reset output on the ADM8323, a valid output for V_{CC} as low as 0 V is possible. For this active low reset output, a resistor connected between $\overline{\text{RESET}}$ and ground pulls the output low when it is unable to sink current. Use a large resistance, such as 100 k Ω , so that it does not overload the reset output when V_{CC} is above 0.9 V.

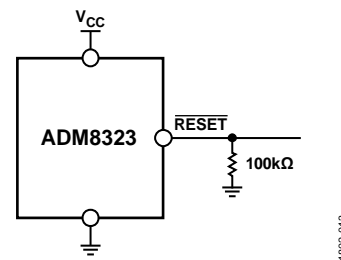

Figure 24. Ensuring $\overline{\text{RESET}}$ Valid to $V_{CC} = 0$ V

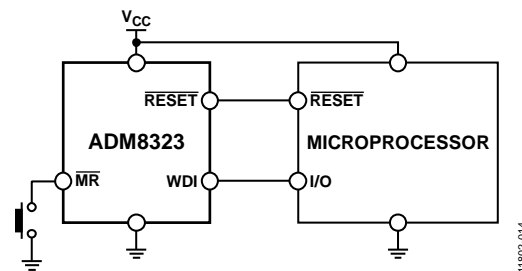

Figure 25. ADM8323 Typical Application Circuit

DEVICE MODEL OPTIONS

The ADM8323/ADM8324 include many device options; however, not all options are released for sale. Released options are called standard models and are listed in the Ordering Guide. For the most up to date list of standard models, refer to the Analog Devices website at www.analog.com/supervisory. Contact an Analog Devices sales representative for information on nonstandard models, and be aware that samples and production units have long lead times.

Table 4. Reset Timeout Options

Suffix	Minimum	Typical	Maximum	Unit
A	1	1.4	1.8	ms
B	20	28	36	ms
C	140	200	260	ms
D	1120	1600	2080	ms

Table 5. Watchdog Timeout Options

Suffix	Fast		Slow	
	Maximum	Unit	Minimum	Unit
A	1.5	ms	10	ms
B	15	ms	100	ms
C	15	ms	300	ms
D	15	ms	10	sec
E	15	ms	60	sec
F	24	ms	44	ms
G	41	ms	76	ms
H	768	ms	1.24	sec

Table 6. Reset Voltage Threshold Options

Reset Threshold Number	T _A = 25°C			T _A = -40°C to +125°C		Unit
	Minimum	Typical	Maximum	Minimum	Maximum	
50	4.950	5.000	5.050	4.925	5.075	V
49	4.851	4.900	4.949	4.826	4.974	V
48	4.752	4.800	4.848	4.728	4.872	V
47	4.653	4.700	4.747	4.629	4.771	V
46	4.584	4.630	4.676	4.560	4.700	V
45	4.455	4.500	4.545	4.432	4.568	V
44	4.346	4.390	4.434	4.324	4.456	V
43	4.257	4.300	4.343	4.235	4.365	V
42	4.158	4.200	4.242	4.137	4.263	V
41	4.059	4.100	4.141	4.038	4.162	V
40	3.960	4.00	4.040	3.940	4.060	V
39	3.861	3.900	3.939	3.841	3.959	V
38	3.762	3.800	3.838	3.743	3.857	V
37	3.663	3.700	3.737	3.644	3.756	V
36	3.564	3.600	3.636	3.546	3.654	V
35	3.465	3.500	3.535	3.447	3.553	V
34	3.366	3.400	3.434	3.349	3.451	V
33	3.267	3.300	3.333	3.250	3.350	V
32	3.168	3.200	3.232	3.152	3.248	V
31	3.049	3.080	3.111	3.033	3.127	V
30	2.970	3.000	3.030	2.955	3.045	V
29	2.901	2.930	2.959	2.886	2.974	V
28	2.772	2.800	2.828	2.758	2.842	V
27	2.673	2.700	2.727	2.659	2.741	V
26	2.604	2.630	2.656	2.590	2.670	V
25	2.475	2.500	2.525	2.462	2.538	V

OUTLINE DIMENSIONS

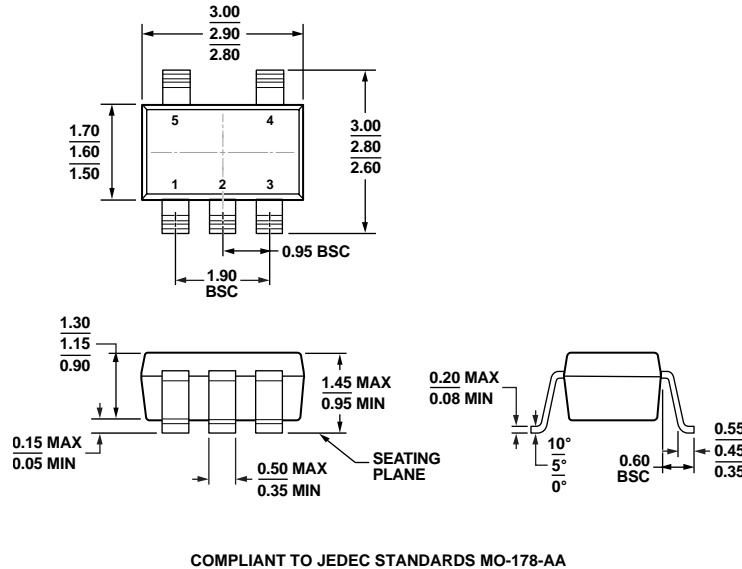

COMPLIANT TO JEDEC STANDARDS MO-178-AA
 Figure 26. 5-Lead Small Outline Transistor Package [SOT-23] (RJ-5)

Dimensions shown in millimeters

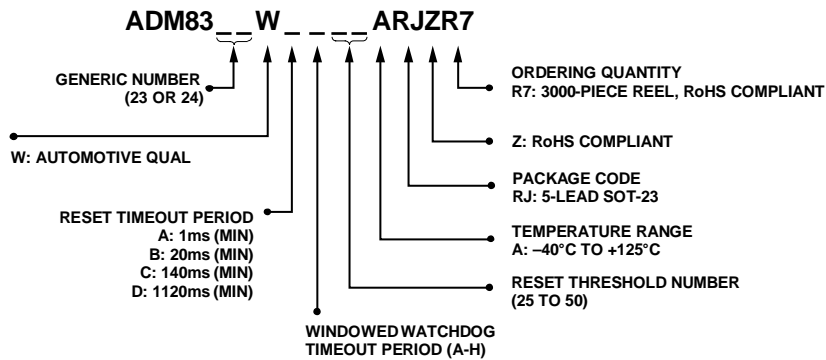

Figure 27. Ordering Code Structure

ORDERING GUIDE

Model ^{1,2,3,4}	Temperature Range	Reset Threshold (V)	Max Fast Timeout (ms)	Min Slow Timeout (ms)	Min Reset Timeout (ms)	Ordering Quantity	Package Description	Package Option	Marking Code
ADM8323WCC29ARJZR7	-40°C to +125°C	2.93	15	300	140	3,000	5-Lead SOT-23	RJ-5	LNO
ADM8323WCC46ARJZR7	-40°C to +125°C	4.63	15	300	140	3,000	5-Lead SOT-23	RJ-5	LNO
ADM8324WAH29ARJZR7	-40°C to +125°C	2.93	768	1240	1	3,000	5-Lead SOT-23	RJ-5	LMU
ADM8324WCA29ARJZR7	-40°C to +125°C	2.93	1.5	10	140	3,000	5-Lead SOT-23	RJ-5	LMU
ADM8324WCA46ARJZR7	-40°C to +125°C	4.63	1.5	10	140	3,000	5-Lead SOT-23	RJ-5	LMU

¹ Z = RoHS Compliant Part.

² W = Qualified for Automotive Applications.

³ The ADM8323/ADM8324 include many device options; however, not all options are released for sale. Released options are called standard models and are listed in the Ordering Guide. For the most up to date list of standard models, refer to the Analog Devices website at www.analog.com/supervisory. Contact an Analog Devices sales representative for information on nonstandard models, and be aware that samples and production units have long lead times.

⁴ If ordering nonstandard models, complete the ordering code shown in Figure 27 by inserting reset timeout, watchdog timeout, and reset threshold suffixes from Table 4 to Table 6.

AUTOMOTIVE PRODUCTS

The [ADM8323W/ADM8324W](#) model are available with controlled manufacturing to support the quality and reliability requirements of automotive applications. Note that these automotive models may have specifications that differ from the commercial models; therefore, designers should review the Specifications section of this data sheet carefully. Only the automotive grade products shown are available for use in automotive applications. Contact your local Analog Devices, Inc., account representative for specific product ordering information and to obtain the specific Automotive Reliability reports for these models.

NOTES